

**ПРАЙС-ЛИСТ НА КОМПРЕССИОННЫЕ  
ФИТИНГИ ИЗ ПОЛИЭТИЛЕНА  
ФИРМЫ "VDL" (Голландия)**

**2022г. (1)**



Оплата производится в рублях по курсу ЦБ

Оптовым покупателям и дилерам предоставляются скидки.

Код по каталогу	PN	d, мм	Z, мм	B, мм	Розничная цена, евро
<b>Угольник ПЭ, Van De Lande</b>					
7.20.016	16	16	10,0	42	<b>3,34</b>
7.20.020	16	20	12,0	47	<b>4,18</b>
7.20.025	16	25	14,0	51	<b>5,24</b>
7.20.032	16	32	18,0	57	<b>6,51</b>
7.20.040	16	40	21,0	61	<b>8,63</b>
7.20.050	16	50	28,0	98	<b>17,95</b>
7.20.063	16	63	50,0	110	<b>28,07</b>
7.20.075	10	75	38,0	124	<b>43,42</b>

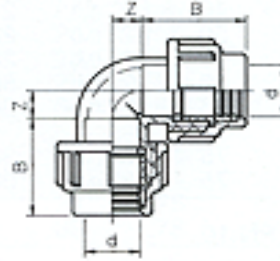

Код по каталогу	d, мм	d2, мм	Z, мм	Z2, мм	B, мм	C, мм	Розничная цена, евро
<b>Угольник ПЭ, Van De Lande</b>							
7.22.016	16	3/8"(M)	10	34	42	11	<b>2,78</b>
7.22.017	16	1/2"(M)	10	34	42	13	<b>2,78</b>
7.22.020	20	1/2"(M)	12	34	47	16	<b>3,27</b>
7.22.021	20	3/4"(M)	12	34	47	17	<b>3,27</b>
7.22.024	25	1/2"(M)	14	38	51	19	<b>3,75</b>
7.22.025	25	3/4"(M)	14	38	51	19	<b>3,75</b>
7.22.026	25	1"(M)	14	38	51	21	<b>3,75</b>
7.22.032	32	1"(M)	18	44	57	21	<b>4,66</b>
7.22.033	32	1 1/4"(M)	18	44	57	23	<b>4,66</b>
7.22.040	40	1 1/4"(M)	21	47	61	23	<b>6,30</b>
7.22.041	40	1 1/2"(M)	21	47	61	23	<b>6,30</b>
7.22.050	50	1 1/2"(M)	28	59	98	26	<b>12,76</b>
7.22.051	50	2"(M)	28	59	98	26	<b>12,76</b>
7.22.063	63	2"(M)	50	76	110	31	<b>19,47</b>
7.22.074	75	2"(M)	38	77	124	26	<b>42,83</b>
7.22.075	75	2 1/2"(M)	38	77	124	34	<b>42,83</b>
7.22.076	75	3"(M)	38	77	124	34	<b>42,83</b>

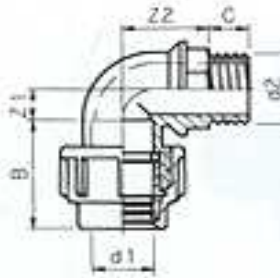

Код по каталогу	d, мм	d2, мм	Z, мм	Z2, мм	B, мм	C, мм	Розничная цена, евро
<b>Угольник ПЭ, Van De Lande</b>							
7.24.016	16	3/8"(F)	10	31	42	11	<b>2,95</b>
7.24.017	16	1/2"(F)	10	31	42	13	<b>2,95</b>
7.24.020	20	1/2"(F)	12	31	47	16	<b>3,27</b>
7.24.021	20	3/4"(F)	12	31	47	17	<b>3,27</b>
7.24.024	25	1/2"(F)	14	36	51	16	<b>3,75</b>
7.24.025	25	3/4"(F)	14	36	51	17	<b>3,75</b>
7.24.026	25	1"(F)	14	36	51	21	<b>3,75</b>
7.24.032	32	1"(F)	18	40	57	21	<b>4,66</b>
7.24.033	32	1 1/4"(F)	18	40	57	23	<b>4,66</b>
7.24.040	40	1 1/4"(F)	21	45	61	23	<b>6,66</b>
7.24.041	40	1 1/2"(F)	21	45	61	23	<b>6,66</b>

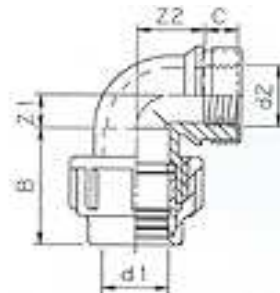

Код по каталогу	d, мм	d2, мм	Z, мм	Z2, мм	B, мм	C, мм	Розничная цена, евро
<b>Угольник ПЭ, Van De Lande</b>							
7.25.016	16	3/8"(F)	10	31	42	11	<b>4,00</b>
7.25.017	16	1/2"(F)	10	31	42	13	<b>4,06</b>
7.25.020	20	1/2"(F)	12	31	47	16	<b>4,36</b>
7.25.021	20	3/4"(F)	12	31	47	17	<b>4,40</b>
7.25.024	25	1/2"(F)	14	31	51	16	<b>4,88</b>
7.25.025	25	3/4"(F)	14	36	51	17	<b>4,88</b>
7.25.026	25	1"(F)	14	36	51	21	<b>5,02</b>
7.25.032	32	1"(F)	18	40	57	21	<b>5,94</b>
7.25.033	32	1 1/4"(F)	18	40	57	23	<b>6,12</b>
7.25.040	40	1 1/4"(F)	21	45	61	23	<b>8,11</b>
7.25.041	40	1 1/2"(F)	21	45	61	23	<b>8,24</b>
7.24.049	50	1 1/4"(F)	28	55	98	31	<b>22,85</b>
7.24.050	50	1 1/2"(F)	28	60	98	26	<b>22,85</b>
7.24.051	50	2"(F)	28	53	98	26	<b>22,85</b>
7.24.062	63	1 1/2"(F)	50	80	110	26	<b>24,96</b>
7.24.063	63	2"(F)	50	75	110	31	<b>24,96</b>
7.24.074	75	2"(F)	38	75	124	34	<b>42,83</b>
7.24.075	75	2 1/2"(F)	38	75	124	31	<b>42,83</b>
7.24.076	75	3"(F)	38	78	124	34	<b>42,83</b>

Код по каталогу	d, мм	d2, мм	Z, мм	Z2, мм	B, мм	C, мм	Розничная цена, евро
<b>ПВХ/ПЭ угольник, Van De Lande</b>							
7.21.015	16	25	15	37	42	19	<b>2,82</b>
7.21.016	16	32	12	34	42	22	<b>2,82</b>
7.21.019	20	25	15	37	47	19	<b>2,82</b>
7.21.020	20	32	12	34	47	22	<b>2,82</b>
7.21.024	25	25	15	37	51	19	<b>3,27</b>
7.21.025	25	32	14	34	51	22	<b>3,27</b>

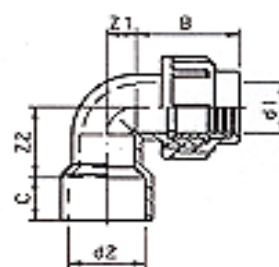
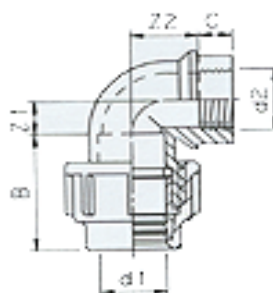
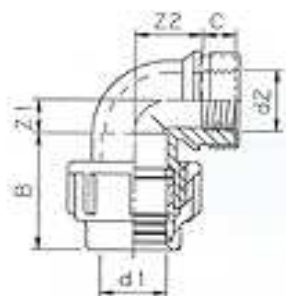

Код по каталогу	PN	d, мм	Z, мм	B, мм	Розничная цена, евро
<b>Тройник ПЭ, Van De Lande</b>					
7.10.016	16	16	10,0	42	<b>4,45</b>
7.10.020	16	20	12,0	47	<b>5,60</b>
7.10.025	16	25	14,0	51	<b>7,00</b>
7.10.032	16	32	18,0	57	<b>9,33</b>
7.10.040	16	40	21,0	61	<b>13,08</b>
7.10.050	10	50	28,0	98	<b>26,19</b>
7.10.063	10	63	38,0	110	<b>43,00</b>
7.10.075	10	75	38,0	124	<b>71,58</b>

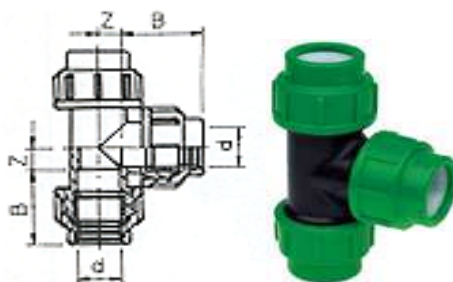

Код по каталогу	d <sub>1</sub>	d <sub>2</sub>	Z <sub>1</sub> , мм	Z <sub>2</sub> , мм	B, мм	C, мм	Розничная цена, евро
<b>ПВХ/ПЭ тройник, Van De Lande</b>							
7.11.049	50	16	14	28,0	31	42	<b>3,99</b>
7.11.050	50	20	14	31,0	31	47	<b>3,99</b>
7.11.055	50	25	14	31,0	31	51	<b>4,11</b>
7.11.059	63	16	15	38,0	38	42	<b>6,80</b>
7.11.060	63	20	15	41,0	38	47	<b>6,80</b>
7.11.065	63	25	15	44,0	38	51	<b>6,95</b>
7.11.066	63	32	15	46,0	38	58	<b>8,35</b>
7.11.069	75	16	15	46,0	44	42	<b>9,91</b>
7.11.070	75	20	15	49,0	44	47	<b>9,91</b>
7.11.075	75	25	15	52,0	44	51	<b>10,03</b>
7.11.076	75	32	15	53,5	44	57	<b>11,42</b>
7.11.079	90	16	15	57,0	51	42	<b>17,93</b>
7.11.080	90	20	15	60,0	51	47	<b>17,93</b>
7.11.085	90	25	15	63,0	51	51	<b>18,09</b>
7.11.086	90	32	15	63,0	51	57	<b>19,48</b>

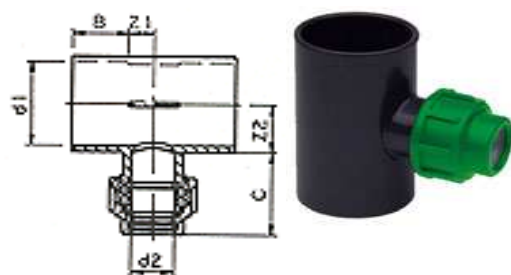

Код по каталогу	d <sub>1</sub>	d <sub>2</sub>	Z <sub>1</sub> , мм	Z <sub>2</sub> , мм	B, мм	C, мм	Розничная цена, евро
<b>ПВХ/ПЭ тройник, Van De Lande</b>							
7.11.016	16	32	20	20	42	22	<b>4,14</b>
7.11.020	20	32	22	20	47	22	<b>4,14</b>
7.11.025	25	32	22	20	51	22	<b>4,27</b>
<b>Тройник ПЭ, Van De Lande</b>							
7.12.016	16	3/8"(м)	10	34,0	42	11	<b>3,75</b>
7.12.017	16	1/2"(м)	10	34,0	42	13	<b>3,75</b>
7.12.020	20	1/2"(м)	12	34,0	47	16	<b>4,66</b>
7.12.021	20	3/4"(м)	12	34,0	47	17	<b>4,66</b>
7.12.024	25	1/2"(м)	14	37,0	51	16	<b>6,08</b>
7.12.025	25	3/4"(м)	14	38,0	51	17	<b>6,08</b>
7.12.026	25	1"(м)	14	38,0	51	21	<b>6,08</b>
7.12.032	32	1"(м)	18	44,0	57	21	<b>7,93</b>
7.12.033	32	1 1/4"(м)	18	44,0	57	23	<b>7,93</b>
7.12.040	40	1 1/4"(м)	21	47,0	61	23	<b>10,75</b>
7.12.041	40	1 1/2"(м)	21	47,0	61	23	<b>10,75</b>
7.12.051	50	2"(м)	28	51,0	98	31	<b>23,53</b>
7.12.062	63	1 1/2"(м)	38	60,0	110	24	<b>32,15</b>
7.12.063	63	2"(м)	38	60,0	110	31	<b>32,15</b>
7.12.074	75	2"(м)	38	72,0	124	31	<b>66,59</b>
7.12.075	75	2 1/2"(м)	38	72,0	124	34	<b>66,59</b>
7.12.076	75	3"(м)	38	72,0	124	34	<b>66,59</b>

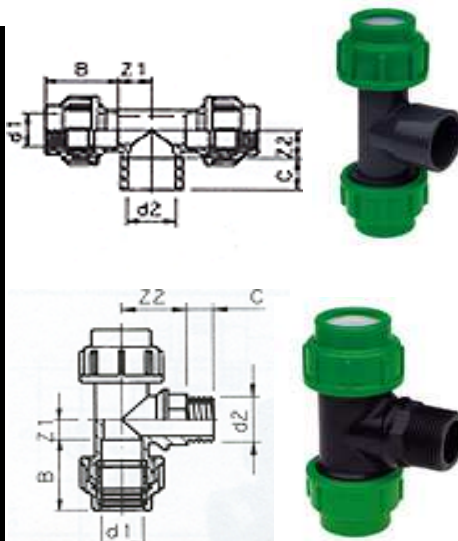

Тройники ПЭ (Van De Lande BV)

Код по каталогу	d <sub>1</sub>	d <sub>2</sub>	Z <sub>1</sub> , мм	Z <sub>2</sub> , мм	B, мм	C, мм	Розничная цена, евро
<b>Тройник ПЭ, Van De Lande</b>							
7.14.016	16	3/8"(F)	10	31,0	42	11	<b>3,97</b>
7.14.017	16	1/2"(F)	10	31,0	42	13	<b>3,97</b>
7.14.020	20	1/2"(F)	12	31,0	47	16	<b>4,88</b>
7.14.021	20	3/4"(F)	12	31,0	47	17	<b>4,88</b>
7.14.024	25	1/2"(F)	14	31,0	51	16	<b>6,30</b>
7.14.025	25	3/4"(F)	14	36,0	51	17	<b>6,30</b>
7.14.026	25	1"(F)	14	36,0	51	21	<b>6,30</b>
7.14.032	32	1"(F)	18	40,0	57	21	<b>8,42</b>
7.14.033	32	1 1/4"(F)	18	40,0	57	23	<b>8,42</b>
7.14.040	40	1 1/4"(F)	21	45,0	61	23	<b>11,66</b>
7.14.041	40	1 1/2"(F)	21	45,0	61	23	
7.15.016	16	3/8"(F)	10	31,0	42	11	<b>5,02</b>
7.15.017	16	1/2"(F)	10	31,0	42	13	<b>5,06</b>
7.15.020	20	1/2"(F)	12	31,0	47	16	<b>5,99</b>
7.15.021	20	3/4"(F)	12	31,0	47	17	<b>6,03</b>
7.15.024	25	1/2"(F)	14	31,0	51	16	<b>7,45</b>
7.15.025	25	3/4"(F)	14	36,0	51	17	<b>7,45</b>
7.15.026	25	1"(F)	14	36,0	51	21	<b>7,57</b>
7.15.032	32	1"(F)	18	40,0	57	21	<b>9,69</b>
7.15.033	32	1 1/4"(F)	18	40,0	57	23	<b>9,87</b>
7.15.040	40	1 1/4"(F)	21	45,0	61	23	<b>13,12</b>
7.15.041	40	1 1/2"(F)	21	45,0	61	23	<b>13,26</b>
7.14.050	50	1 1/2"(F)	28	45,0	98	26	<b>26,31</b>
7.14.051	50	2"(F)	28	56,0	98	31	<b>26,31</b>
7.14.062	63	1 1/2"(F)	38	60,0	110	26	<b>37,83</b>
7.14.063	63	2"(F)	38	65,0	110	31	<b>37,83</b>
7.14.074	75	2"(F)	38	70,0	124	31	<b>66,59</b>
7.14.075	75	2 1/2"(F)	38	70,0	124	31	<b>66,59</b>
7.14.076	75	3"(F)	38	76,0	124	34	<b>66,59</b>

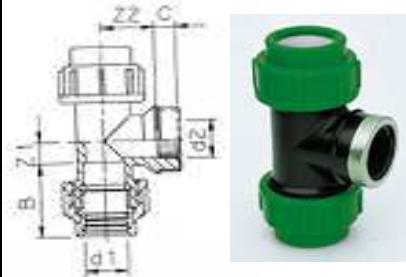

Код по каталогу	d <sub>1</sub>	d <sub>2</sub>	Z <sub>1</sub> , мм	Z <sub>2</sub> , мм	B, мм	C, мм	Розничная цена, евро
<b>Тройник ПЭ, Van De Lande</b>							
7.16.020	20	16	10	24	47	42	<b>5,37</b>
7.16.024	1	16	15	16	51	42	<b>6,51</b>
7.16.025	25	20	15	26	51	47	<b>6,51</b>
7.16.032	32	25	19	31	57	51	<b>8,42</b>
7.16.040	40	32	23	36	61	57	<b>11,18</b>
7.16.050	50	40	28	40	98	72	<b>18,67</b>
7.16.063	63	50	38	36	110	98	<b>40,47</b>
7.16.075	75	63	38	39	124	110	<b>71,36</b>

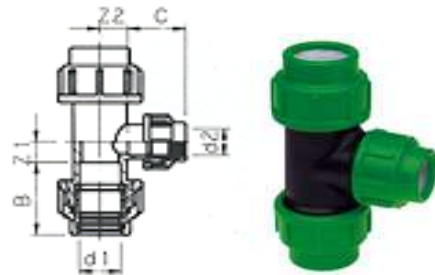

Код по каталогу	d1, мм	d2, мм	d3, мм	L, мм	Z, мм	C, мм	Розничная цена за 1шт. с учетом НДС, евро
<b>Седельный хомут PP, болты с гальв.покрытием, Van De Lande</b>							
6.50.020	20	1/2"(F)	10	42	16	18	<b>6,70</b>
6.50.025	25	1/2"(F)	12	50	19	18	<b>6,88</b>
6.50.032	32	1/2"(F)	14	54	23	18	<b>7,09</b>
6.50.033	32	3/4"(F)	18	54	23	19	<b>7,35</b>
6.50.034	32	1"(F)	23	54	23	22	<b>7,35</b>
6.50.040	40	1/2"(F)	14	60	27	18	<b>8,17</b>
6.50.041	40	3/4"(F)	18	60	27	19	<b>8,60</b>
6.50.042	40	1"(F)	23	60	27	22	<b>8,60</b>
6.50.050	50	1/2"(F)	14	70	32	18	<b>8,60</b>
6.50.051	50	3/4"(F)	18	70	32	19	<b>9,07</b>
6.50.052	50	1"(F)	23	70	32	22	<b>9,07</b>
6.50.053	50	1 1/4"(F)	26	70	32	24	<b>9,07</b>
6.50.063	63	1/2"(F)	14	80	39	18	<b>9,96</b>
6.50.064	63	3/4"(F)	18	80	39	19	<b>9,96</b>
6.50.065	63	1"(F)	23	80	39	22	<b>9,96</b>
6.50.066	63	1 1/4"(F)	26	80	39	24	<b>9,96</b>
6.50.067	63	1 1/2"(F)	33	80	39	24	<b>9,96</b>
6.50.075	75	1/2"(F)	14	92	46	18	<b>12,16</b>
6.50.076	75	3/4"(F)	18	92	46	19	<b>12,16</b>
6.50.077	75	1"(F)	23	92	46	22	<b>12,16</b>
6.50.078	75	1 1/4"(F)	26	92	46	24	<b>12,16</b>
6.50.079	75	1 1/2"(F)	33	92	46	24	<b>12,16</b>
6.50.080	75	2"(F)	42	92	46	28	<b>12,16</b>
6.50.090	90	1/2"(F)	14	98	53	18	<b>13,74</b>
6.50.091	90	3/4"(F)	18	98	53	19	<b>13,74</b>
6.50.092	90	1"(F)	23	98	53	22	<b>13,74</b>
6.50.093	90	1 1/4"(F)	26	98	53	24	<b>13,74</b>
6.50.094	90	1 1/2"(F)	33	98	53	24	<b>13,74</b>
6.50.095	90	2"(F)	42	98	53	28	<b>13,74</b>
6.50.110	110	1"(F)	23	114	64	22	<b>16,89</b>
6.50.111	110	1 1/4"(F)	26	114	64	24	<b>16,89</b>
6.50.112	110	1 1/2"(F)	33	114	64	24	<b>16,89</b>
6.50.113	110	2"(F)	42	114	64	28	<b>16,89</b>
6.50.114	110	2 1/2"(F)	60	114	64	33	<b>17,60</b>
6.50.125	125	1"(F)	23	120	71	22	<b>21,84</b>
6.50.126	125	1 1/4"(F)	26	120	71	24	<b>21,84</b>
6.50.127	125	1 1/2"(F)	33	120	71	24	<b>21,84</b>
6.50.128	125	2"(F)	42	120	71	28	<b>21,84</b>
6.50.129	125	2 1/2"(F)	60	120	71	33	<b>21,84</b>
6.50.140	140	1 1/4"(F)	26	130	80	24	<b>26,39</b>
6.50.141	140	2"(F)	42	130	80	28	<b>26,39</b>
6.50.142	140	2 1/2"(F)	60	130	80	33	<b>26,39</b>
6.50.160	160	1"(F)	23	144	90	33	<b>35,39</b>
6.50.161	160	1 1/4"(F)	26	144	90	24	<b>35,39</b>
6.50.162	160	1 1/2"(F)	33	144	90	24	<b>35,39</b>
6.50.163	160	2"(F)	42	144	90	28	<b>35,39</b>
6.50.164	160	2 1/2"(F)	60	144	94	33	<b>35,39</b>
6.50.165	160	3"(F)	76	144	94	36	<b>35,39</b>

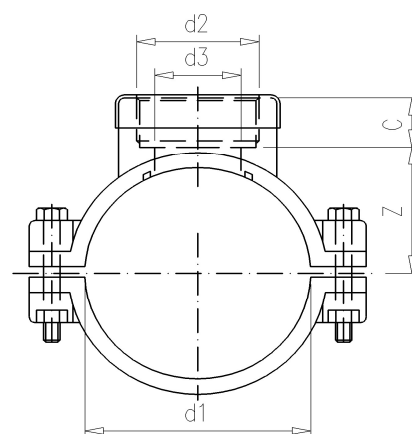
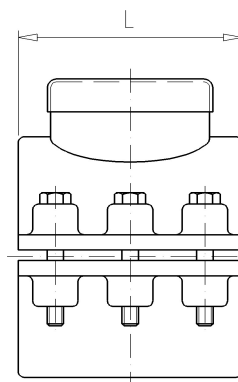



Код по каталогу	d1, мм	d2, мм	d3, мм	L, мм	Z, мм	C, мм	Розничная цена за 1шт. с учетом НДС, евро
<b>Седельный хомут PP, наружная резьба, Van De Lande</b>							
6.55.020	20	1/2"(F)	10	42	16	18	<b>6,07</b>
6.55.025	25	1/2"(F)	12	50	19	18	
6.55.032	32	1/2"(F)	14	54	23	18	<b>6,46</b>
6.55.033	32	3/4"(F)	18	54	23	19	<b>6,79</b>
6.55.034	32	1"(F)	23	54	23	22	<b>6,79</b>
6.55.040	40	1/2"(F)	14	60	27	18	<b>7,53</b>
6.55.041	40	3/4"(F)	18	60	27	19	<b>7,91</b>
6.55.042	40	1"(F)	23	60	27	22	<b>7,91</b>
6.55.050	50	1/2"(F)	14	70	32	18	<b>8,17</b>
6.55.051	50	3/4"(F)	18	70	32	19	<b>8,38</b>
6.55.052	50	1"(F)	23	70	32	22	<b>8,38</b>
6.55.053	50	1 1/4"(F)	26	70	32	24	<b>8,38</b>
6.55.063	63	1/2"(F)	14	80	39	18	<b>9,07</b>
6.55.064	63	3/4"(F)	18	80	39	19	<b>9,07</b>
6.55.065	63	1"(F)	23	80	39	22	<b>9,07</b>
6.55.066	63	1 1/4"(F)	26	80	39	24	<b>9,07</b>
6.55.067	63	1 1/2"(F)	33	80	39	24	<b>9,07</b>
6.55.075	75	1/2"(F)	14	92	46	18	<b>11,11</b>
6.55.076	75	3/4"(F)	18	92	46	19	
6.55.077	75	1"(F)	23	92	46	22	<b>11,11</b>
6.55.078	75	1 1/4"(F)	26	92	46	24	<b>11,11</b>
6.55.079	75	1 1/2"(F)	33	92	46	24	<b>11,11</b>
6.55.080	75	2"(F)	42	92	46	28	<b>11,11</b>
6.55.090	90	1/2"(F)	14	98	53	18	<b>11,27</b>
6.55.091	90	3/4"(F)	18	98	53	19	<b>11,27</b>
6.55.092	90	1"(F)	23	98	53	22	<b>11,27</b>
6.55.093	90	1 1/4"(F)	26	98	53	24	<b>11,27</b>
6.55.094	90	1 1/2"(F)	33	98	53	24	
6.55.095	90	2"(F)	42	98	53	28	<b>11,27</b>
6.55.110	110	1"(F)	23	114	64	22	<b>15,44</b>
6.55.111	110	1 1/4"(F)	26	114	64	24	<b>15,44</b>
6.55.112	110	1 1/2"(F)	33	114	64	24	<b>15,44</b>
6.55.113	110	2"(F)	42	114	64	28	<b>15,44</b>
6.55.114	110	2 1/2"(F)	60	114	64	33	<b>15,44</b>
6.55.125	125	1"(F)	23	120	71	22	<b>19,85</b>
6.55.126	125	1 1/4"(F)	26	120	71	24	<b>19,85</b>
6.55.127	125	1 1/2"(F)	33	120	71	24	<b>19,85</b>
6.55.128	125	2"(F)	42	120	71	28	<b>19,85</b>
6.55.129	125	2 1/2"(F)	60	120	71	33	<b>19,85</b>
6.55.140	140	1 1/4"(F)	26	130	80	24	<b>23,88</b>
6.55.141	140	2"(F)	42	130	80	28	<b>23,88</b>
6.55.142	140	2 1/2"(F)	60	130	80	33	<b>23,88</b>
6.55.160	160	1"(F)	23	144	90	33	<b>31,78</b>
6.55.161	160	1 1/4"(F)	26	144	90	24	<b>31,78</b>
6.55.162	160	1 1/2"(F)	33	144	90	24	<b>31,78</b>
6.55.163	160	2"(F)	42	144	90	28	<b>31,78</b>
6.55.164	160	2 1/2"(F)	60	144	94	33	
6.55.165	160	3"(F)	76	144	94	36	<b>31,78</b>

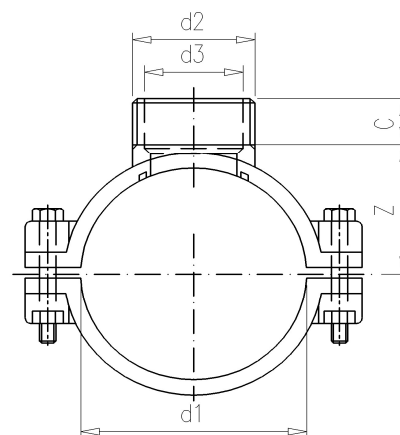
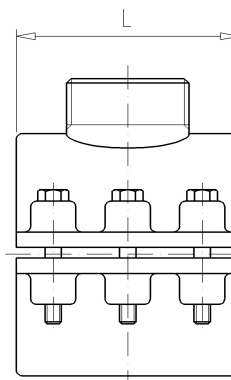

Краны шаровые ПЭ (Van De Lande BV)

Код по каталогу	d1, мм	d2, мм	d3, мм	d4, мм	Z1, мм	Z2, мм	B, мм	C, мм	D, мм	DN	Розничная цена, евро
<b>Кран шаровой двухходовой PVC-U, Van De Lande</b>											
6.00.016	25,0	32	16	20	70,0	55,0	19,0	22	42	20	<b>13,44</b>
6.00.020	25,0	32	20	20	68,0	55,0	19,0	22	47	20	<b>13,44</b>
6.00.025	25,0	32	25	20	66,0	55,0	19,0	22	51	20	<b>13,44</b>
6.00.032	32,0	40	32	25	70,0	55,0	22,0	26	57	25	<b>16,14</b>

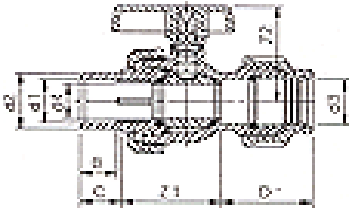

Код по каталогу	d1	d2	B, мм	Z, мм	Розничная цена, евро
<b>Обратный клапан для шланга ПЭ, Van De Lande</b>					
4.22.016	15	13	50	28	<b>3,75</b>
4.22.020	19	17	50	28	<b>3,75</b>
4.22.025	23	21	50	28	<b>3,75</b>

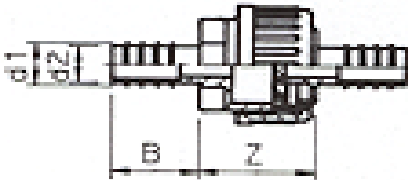



Код по каталогу	d <sub>1</sub> , мм	Z, мм	B, мм	S, мм	Розничная цена, евро
<b>Соединение ПЭ, Van De Lande</b>					
7.30.016	16	3	42	24	<b>3,52</b>
7.30.020	20	3	47	27	<b>4,18</b>
7.30.025	25	3	51	33	<b>5,15</b>
7.30.032	32	3	57	42	<b>6,51</b>
7.30.040	40	3	61	51	<b>8,63</b>
7.30.050	50	3	98	-	<b>15,45</b>
7.30.063	63	3	110	-	<b>25,63</b>
7.30.075	75	3	124	-	<b>38,39</b>
7.30.090	90	5	180	-	<b>92,99</b>
7.30.110	110	7	200	-	<b>183,03</b>

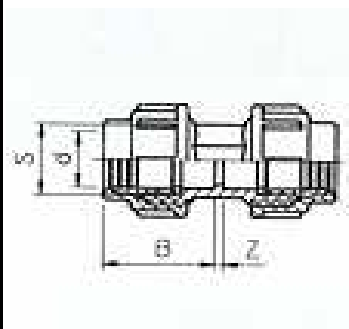

Код по каталогу	d <sub>1</sub> , мм	d <sub>2</sub> , мм	Z, мм	B, мм	C, мм	S, мм	Розничная цена, евро
<b>Соединение ПЭ, Van De Lande</b>							
7.32.016	16	3/8"(M)	3	42	11	24	<b>2,06</b>
7.32.017	16	1/2"(M)	3	42	13	24	<b>2,06</b>
7.32.020	20	1/2"(M)	3	47	16	27	<b>2,25</b>
7.32.021	20	3/4"(M)	3	47	17	27	<b>2,25</b>
7.32.025	25	1/2"(M)	3	51	16	33	<b>2,43</b>
7.32.026	25	3/4"(M)	3	51	17	33	<b>2,43</b>
7.32.027	25	1"(M)	4	51	21	33	<b>2,43</b>
7.32.031	32	1/2"(M)	4	57	16	42	<b>3,57</b>
7.32.032	32	3/4"(M)	4	57	17	42	<b>3,57</b>
7.32.033	32	1"(M)	4	57	21	42	<b>3,57</b>
7.32.034	32	1 1/4"(M)	4	57	23	42	<b>3,57</b>
7.32.040	40	1"(M)	4	61	21	51	<b>5,60</b>
7.32.041	40	1 1/4"(M)	4	61	23	51	<b>5,60</b>
7.32.042	40	1 1/2"(M)	4	61	23	51	<b>5,60</b>
7.32.050	50	1 1/2"(M)	14	98	26	-	<b>9,57</b>
7.32.051	50	2"(M)	14	98	26	-	<b>9,57</b>
7.32.062	63	1 1/2"(M)	10	110	26	-	<b>15,81</b>
7.32.063	63	2"(M)	10	110	26	-	<b>15,81</b>
7.32.074	75	2"(M)	8	124	32	-	<b>24,61</b>
7.32.075	75	2 1/2"(M)	8	124	34	-	<b>24,61</b>
7.32.076	75	3"(M)	8	124	34	-	<b>24,61</b>
7.32.090	90	2"(M)	16	180	34	-	<b>51,35</b>
7.32.091	90	3"(M)	16	180	37	-	<b>51,35</b>
7.32.109	110	3"(M)	8	200	46	-	<b>118,48</b>
7.32.110	110	4"(M)	8	200	52	-	<b>118,48</b>

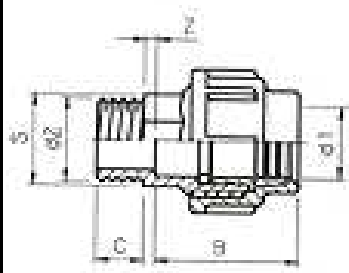

Код по каталогу	d1, мм	d2, мм	Z, мм	B, мм	C, мм	S, мм	Розничная цена, евро
<b>Соединение ПЭ, Van De Lande</b>							
7.34.016	16	3/8"(F)	3	42	11	24	<b>2,34</b>
7.34.017	16	1/2"(F)	3	42	12	24	<b>2,34</b>
7.34.020	20	3/8"(F)	3	47	12	27	<b>2,51</b>
7.34.021	20	1/2"(F)	3	47	16	27	<b>2,51</b>
7.34.022	20	3/4"(F)	7	47	17	27	<b>2,51</b>
7.34.025	25	1/2"(F)	3	51	16	33	<b>2,82</b>
7.34.026	25	3/4"(F)	3	51	17	33	<b>2,82</b>
7.34.027	25	1"(F)	7	51	21	33	<b>2,82</b>
7.34.031	32	1/2"(F)	4	57	16	42	<b>3,91</b>
7.34.032	32	3/4"(F)	4	57	17	42	<b>3,91</b>
7.34.033	32	1"(F)	4	57	21	42	<b>3,91</b>
7.34.034	32	1 1/4"(F)	9	57	23	42	<b>3,91</b>
7.34.040	40	1"(F)	4	61	21	51	<b>6,08</b>
7.34.041	40	1 1/4"(F)	4	61	23	51	<b>6,08</b>
7.34.042	40	1 1/2"(F)	9	61	23	51	<b>6,08</b>

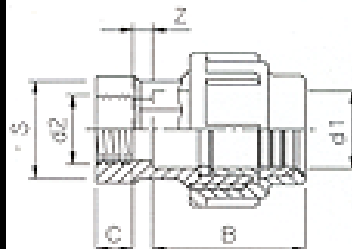

Код по каталогу	d1, мм	d2, мм	Z, мм	B, мм	C, мм	S, мм	Розничная цена, евро
<b>Соединение ПЭ, Van De Lande</b>							
7.35.016	16	3/8"(F)	3	42	11	24	<b>3,39</b>
7.35.017	16	1/2"(F)	3	42	12	24	<b>3,43</b>
7.35.020	20	3/8"(F)	3	47	12	27	<b>3,57</b>
7.35.021	20	1/2"(F)	3	47	16	27	<b>3,61</b>
7.35.022	20	3/4"(F)	7	47	17	27	<b>3,66</b>
7.35.025	25	1/2"(F)	3	51	16	33	<b>3,91</b>
7.35.026	25	3/4"(F)	3	51	17	33	<b>3,97</b>
7.35.027	25	1"(F)	7	51	21	33	<b>4,09</b>
7.35.031	32	1/2"(F)	4	57	16	42	<b>5,06</b>
7.35.032	32	3/4"(F)	4	57	17	42	<b>5,06</b>
7.35.033	32	1"(F)	4	57	21	42	<b>5,21</b>
7.35.034	32	1 1/4"(F)	9	57	23	42	<b>5,37</b>
7.35.040	40	1"(F)	4	61	21	51	<b>7,36</b>
7.35.041	40	1 1/4"(F)	4	61	23	51	<b>7,54</b>
7.35.042	40	1 1/2"(F)	9	61	23	51	<b>7,66</b>
7.34.050	50	1 1/2"(F)	12	98	26	-	<b>14,99</b>
7.34.051	50	2"(F)	7	98	31	-	<b>14,99</b>
7.34.063	63	2"(F)	5	110	31	-	<b>20,95</b>
7.34.074	75	2"(F)	10	124	26	-	<b>34,50</b>
7.34.075	75	2 1/2"(F)	2	124	34	-	<b>34,50</b>
7.34.090	90	2"(F)	16	180	34	-	<b>59,07</b>
7.34.091	90	3"(F)	16	180	37	-	<b>59,07</b>
7.34.109	110	3"(F)	10	200	53	-	<b>155,99</b>
7.34.110	110	4"(F)	10	200	53	-	<b>155,99</b>

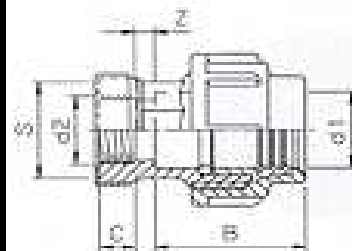

Код по каталогу	d1, мм	d2, мм	Z, мм	B, мм	C, мм	S, мм	Розничная цена, евро
<b>Соединение ПЭ, Van De Lande</b>							
7.36.020	20	16	3	47	42	24	<b>4,45</b>
7.36.024	25	16	3	51	42	24	<b>4,66</b>
7.36.025	25	20	3	51	47	33	<b>4,66</b>
7.36.032	32	25	3	57	51	42	<b>6,08</b>
7.36.040	40	32	3	61	57	51	<b>8,42</b>
7.36.048	50	25	2	98	58	-	<b>14,25</b>
7.36.049	50	32	2	98	64	-	<b>15,31</b>
7.36.050	50	40	2	98	72	-	<b>15,31</b>
7.36.061	63	32	6	110	64	-	<b>20,95</b>
7.36.062	63	40	6	110	72	-	<b>20,95</b>
7.36.063	63	50	6	110	98	-	<b>20,95</b>
7.36.072	75	32	6	124	64	-	<b>29,89</b>
7.36.073	75	40	6	124	72	-	<b>32,88</b>
7.36.074	75	50	6	124	98	-	<b>32,88</b>
7.36.075	75	63	6	124	110	-	<b>32,88</b>

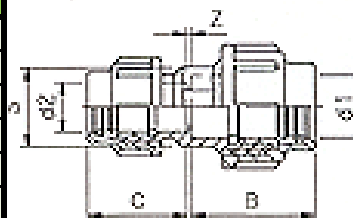

Код по каталогу	d1, мм	d2, мм	Z, мм	B, мм	C, мм	S, мм	Розничная цена, евро
<b>Ниппель с заглушкой ПЭ, Van De Lande</b>							
7.33.016	16	1/2"	3	42	13	24	<b>2,78</b>
7.33.020	20	3/4"	3	47	17	27	<b>3,18</b>
7.33.025	25	3/4"	3	51	17	33	<b>3,66</b>
7.33.032	32	1"	4	57	21	42	<b>4,45</b>
7.33.040	40	1 1/4"	4	61	23	51	<b>6,66</b>
7.33.050	50	1 1/2"	14	98	26	-	<b>11,65</b>
7.33.063	63	2"	10	110	26	-	<b>19,70</b>
7.33.075	75	2 1/2"	8	124	34	-	<b>38,34</b>
7.33.090	90	3"	16	180	37	-	<b>68,52</b>
7.33.110	110	4"	8	200	52	-	<b>140,89</b>

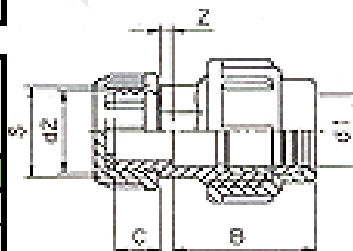

Код по каталогу	d1, мм	d2, мм	d3, мм	Z1, мм	Z2, мм	B, мм	C, мм	Розничная цена, евро
<b>ПВХ/ПЭ соединение, Van De Lande</b>								
7.31.016	16	25	32	6	42	19	22	<b>2,34</b>
7.31.020	20	25	32	8	47	19	22	<b>2,34</b>
7.31.025	25	25	32	11	51	19	22	<b>2,43</b>
7.31.032	32	32	40	14	57	22	26	<b>3,57</b>
7.31.040	40	40	50	15	61	26	31	<b>5,60</b>

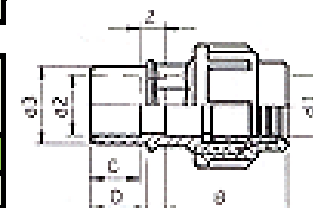

Код по каталогу	D, mm	S, mm	Розничная цена, евро
<b>Кольцо уплотнительное EPDM, Van De Lande</b>			
7.40.016	16	3,5	<b>0,38</b>
7.40.020	20	3,5	<b>0,47</b>
7.40.025	25	3,5	<b>0,47</b>
7.40.032	32	3,5	<b>0,56</b>
7.40.040	40	4,0	<b>0,70</b>
7.40.050	50	5,5	<b>0,85</b>
7.40.063	63	6,0	<b>1,75</b>
7.40.075	75	6,0	<b>1,97</b>
7.40.090	90	8,0	<b>2,73</b>
7.40.110	110	9,0	

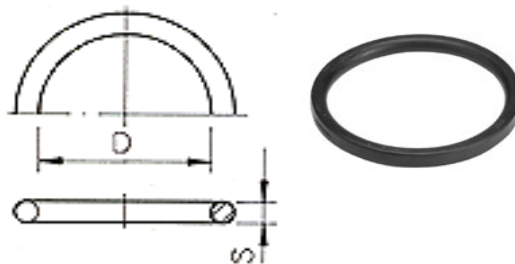

Код по каталогу	D, mm	S, mm	Розничная цена, евро
<b>ПЭ соединительная гайка, Van De Lande</b>			
7.42.016	16	30	<b>0,65</b>
7.42.020	20	20	<b>0,76</b>
7.42.025	25	39	<b>0,93</b>
7.42.032	32	44	<b>1,09</b>
7.42.040	40	47	<b>1,42</b>
7.42.050	50	70	<b>3,27</b>
7.42.063	63	81	<b>8,36</b>
7.42.075	75	88	<b>8,72</b>
7.42.090	90	124	<b>19,42</b>
7.42.110	110	166	<b>35,23</b>

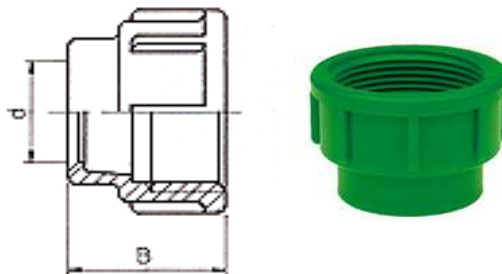

Код по каталогу	D, mm	S, mm	Розничная цена, евро
<b>Стопорное кольцо, Van De Lande</b>			
7.44.016	16		<b>0,47</b>
7.44.020	20	12,0	<b>0,56</b>
7.44.025	25	12,0	<b>0,76</b>
7.44.032	32	16,0	<b>0,93</b>
7.44.040	40	16,0	<b>1,24</b>
7.44.050	50	30,0	<b>2,15</b>
7.44.063	63	32,0	<b>2,82</b>
7.44.075	75	38,0	<b>3,43</b>
7.44.090	90	61,0	<b>5,21</b>
7.44.110	110	61,0	<b>8,81</b>

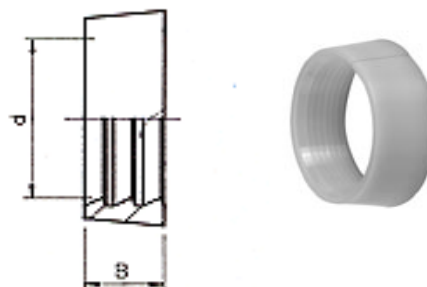

Код по каталогу	D, mm	S, mm	Розничная цена, евро
<b>Крышка ПЭ, Van De Lande</b>			
7.38.016	16	33,0	<b>1,19</b>
7.38.020	20	41,0	<b>1,36</b>
7.38.025	25	41,0	<b>1,58</b>
7.38.032	32	47,0	<b>1,97</b>
7.38.040	40	51,0	<b>2,55</b>

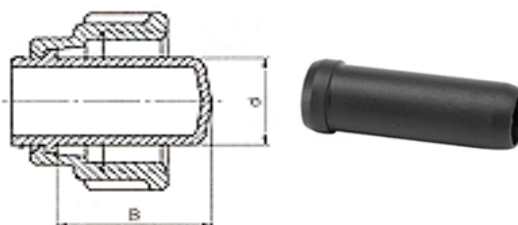

Код по каталогу	Обрабатываемый диаметр, мм	Розничная цена, евро
<b>Инструмент для снятия фасок, Van De Lande</b>		
7.49.010	16 - 63	<b>25,20</b>

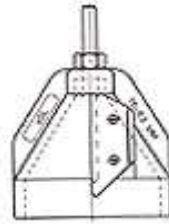

Код по каталогу	d1	d2	В, мм	С, мм	Розничная цена, евро
<b>Крышка ПЭ, Van De Lande</b>					
4.10.016	10	16	17	20	<b>0,85</b>
4.10.020	12	20	18	21	<b>0,85</b>
4.10.025	17	25	21	24	<b>0,97</b>

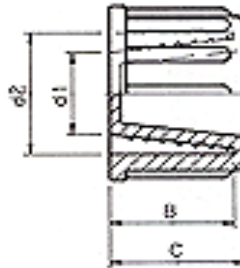



# ООО “РЕСУРС-ПЛАСТ”



## СКЛАД

г.Химки, ул.Рабочая, д.19 (Складской комплекс ОАО "ЭХО")  
8-925-148-26-31, 8-977-611-87-34

Режим работы склада:

Понедельник - Четверг с 8-30 до 17-00

Пятница с 8-30 до 16-00

Обед с 13-00 до 13-45



## ОФИС

г.Москва, Хорошевское шоссе, д.35/1  
(499) 195-25-51, (495) 506-88-55  
(926) 707-88-55

Режим работы офиса:

Понедельник - Четверг с 9-00 до 18-00

Пятница с 9-00 до 17-00

